

# IMP-004 STORAGE SOLUTION

Miniatures Insert Kit for Imperial Assault™ Jabba/Hoth/Heart Boxes  
Complete insert kit providing storage for miniatures, cards, and tokens



RANCOR SHOWN, AT-DP OR RANCOR CAN BE STORED IN THE LARGE MINI TRAY

## Construction Tips

- 1) Each piece should be removed from the frames with gentle pressure back and forth. You should not need a knife to cut pieces free.
- 2) Our inserts are designed to be glued together. We use Sobo craft glue, but any glue that is tacky and dries clear will work fine. Tacky glue assists with building as it holds better during construction. You can use painter's/masking tape for some joins, but glue is always best.
- 3) Keep some paper towels handy for cleanup during build.
- 4) Ensure you cleanup excess glue as you build. This is especially important in card lanes where dividers will be used or in spaces where a tray will be stored. We provide small, thin wood strips that act as glue cleanup sticks in this kit.
- 5) Check the build diagram included in the package for reference, including all parts, as well as build tips specific to this insert.
- 6) Always dry fit pieces first to ensure a good fit and to better understand how the kit goes together.
- 7) Allow your finished insert to dry overnight.
- 8) You can optionally sand and even stain your insert.
- 9) Don't hesitate to reach out to us if you have questions!

Visit [go7gaming.com](http://go7gaming.com) for a large selection of storage solutions. Follow us on Twitter: [@go7gaming](https://twitter.com/go7gaming) and Facebook: [go7gaming](https://www.facebook.com/go7gaming)



Made in the USA

NOT A CHILDREN'S TOY

AGE 14+



# Kit Plates

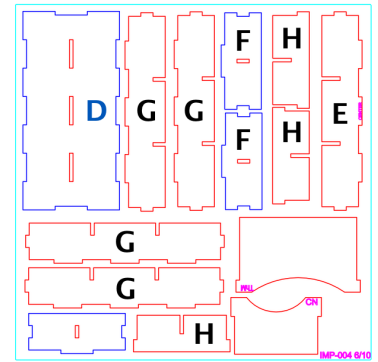
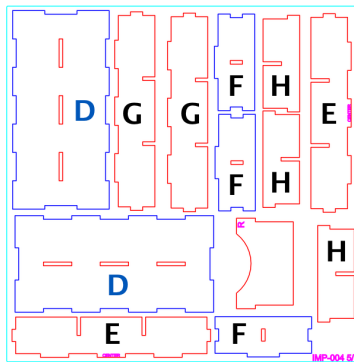
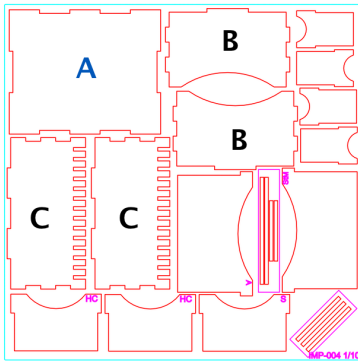

## 3D Models

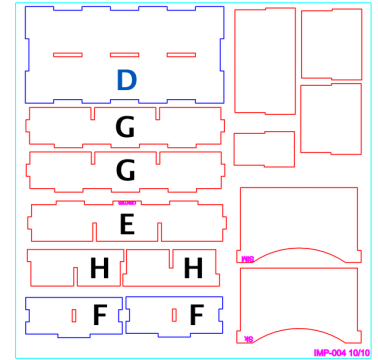
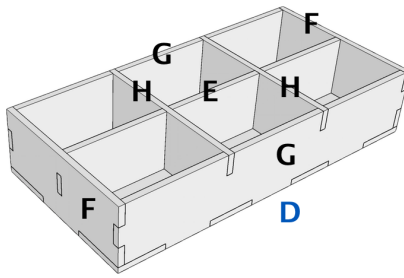
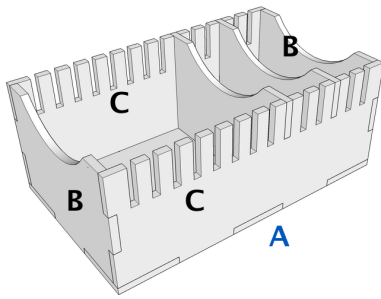

## Build Instructions

This storage solution is designed to fit inside the Return to Hoth or Jabba's Realm boxes of the Imperial Assault game. There are a total of 13 trays provided to store all of your components. This insert is intended to be used in conjunction with our IMPERIAL-001 / IMPERIAL-002 / IMPERIAL-003 storage solutions to provide an overall storage system for your Imperial Assault collection. These instructions will cover constructing the removable trays one-by-one.

Remember, after each piece is placed, you should cleanup excess glue using the provided glue sticks (short, thin wood strips available on several of the plates). Also, remember to dry fit everything so you understand where to place glue and how everything fits together. **Note:** dry fitting is very important when building the minis storage trays. You can dry fit and note how the minis are stored to ensure you don't make a mistake when gluing.

Let's begin by building the large card storage tray first.

- 1) Lay base (A) down on your workspace. Apply glue to the bottom of long side wall (C) and apply glue to the bottom and both side tabs of end wall (B) and then connect them together on base (A).
- 2) Next, apply glue to the bottom of long side wall (C) and connect it to the structure.
- 3) Finally, place glue on the bottom and side tabs of end wall (B) and connect. You may want to place a divider or two into the tray to ensure a perfect fit, just make sure you have cleaned up all of the excess glue.
- 4) Repeat build for the second small card tray.

Next, let's construct the four shallow miniatures storage trays (D).

- 1) Lay base (D) down on your workspace. Apply glue to the bottom of center wall (E) and connect them. **This wall has CENTER engraved on the bottom of one of the tabs.**
- 2) Next, apply glue to the end tabs of center wall (E) and the bottom of end wall (F) and connect. Repeat for the other end wall (F).
- 3) Next, apply glue to bottom and ends of the side wall (G) and connect. Repeat for the other side wall (G).
- 4) Finally, place a small dab of glue on the underside of the divider (H) tabs of each divider and place in the tray.
- 5) Repeat this process for the other three shallow miniatures storage trays.

Allow your trays to dry overnight and then place your components into the trays. Instructions continue on next page.

# Kit Plates

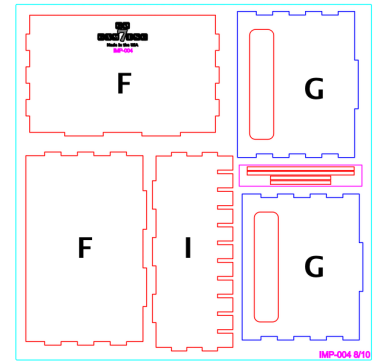
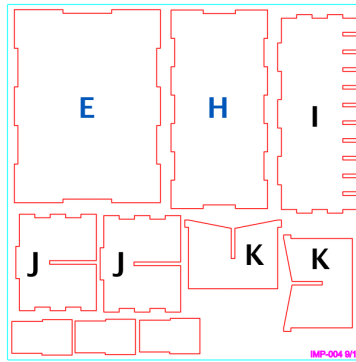
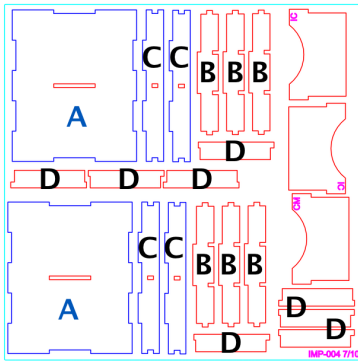

## 3D Models

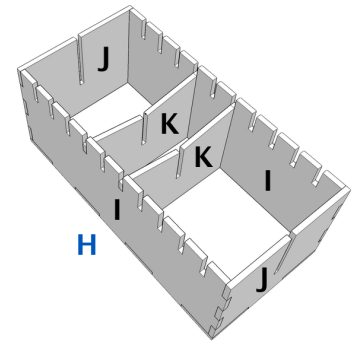
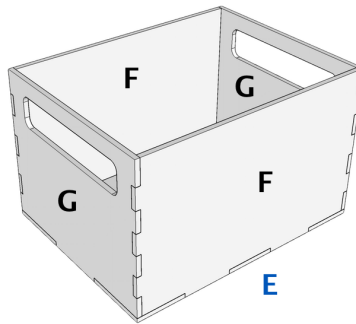
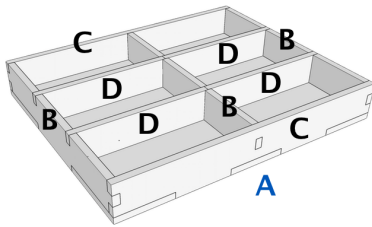

## Build Instructions

Remember, after each piece is placed, you should cleanup excess glue using the provided glue sticks (short, thin wood strips). Also, remember to dry fit everything so you understand where to place glue and how everything fits together. **Note:** dry fitting is very important when building the minis storage trays. You can dry fit and note how the minis are stored to ensure you don't make a mistake when gluing.

Next, let's build the two token storage trays (A). These trays are provided to store additional tokens. **Note:** if you are building this insert for use in the Heart of the Empire box contents, you should not build these two trays. You should build the alternate two token storage trays on the last page of the instructions. Otherwise, build these two trays for use with Return to Hoth.

- 1) Lay base (A) down on your workspace. Apply glue to the bottom of wall (B) and place in the center of base (A).
- 2) Next, apply glue to the end tabs of wall (B) and the bottom of end wall (C) and connect. Repeat for the other end wall (C).
- 3) Next, apply glue to bottom and ends of wall (B) and connect. Repeat for the other side wall (B).
- 4) Finally, carefully place the dividers (D) (no glue) into the tray to allow the tray to dry. You can glue the dividers once you decide how you will store tokens in this tray.
- 5) Repeat this process for the second token storage tray.

Next, let's construct the jumbo miniature storage tray (E). This tray is used to store the Rancor.

- 1) Lay base (E) down on your workspace. Apply glue to the bottom of long side wall (F) and apply glue to the bottom and both side tabs of end wall (G) and then connect all three together.
- 2) Next, apply glue to the bottom of long side wall (F) and connect it to the structure.
- 3) Finally, place glue on the bottom and side tabs of end wall (G) and connect.

Next, let's construct the adjustable miniatures storage tray (H). This tray's layout can be customized to store a wide variety of minis.

- 1) Lay base (H) down on your workspace. Apply glue to the bottom of long side wall (I) and apply glue to the bottom and both side tabs of end wall (J) and then connect all three together.
- 2) Next, apply glue to the bottom of long side wall (I) and connect it to the structure.
- 3) Finally, place glue on the bottom and side tabs of end wall (J) and connect. You may want to place a divider (K) or two into the tray (no glue yet) to ensure a perfect fit, just make sure you have cleaned up all of the excess glue. Once dry, the dividers (K) and splitters can be placed and glued, as needed.

Allow your trays to dry overnight and then place your components into the trays. Instructions continue on next page.

# Kit Plates

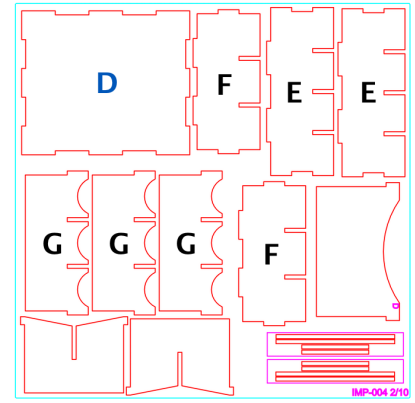
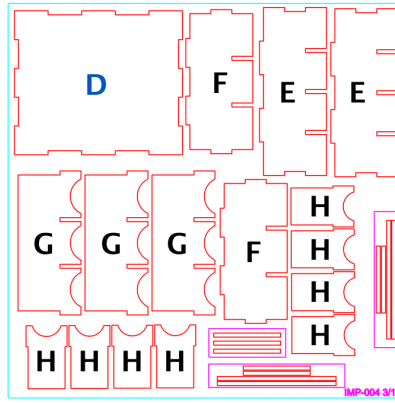
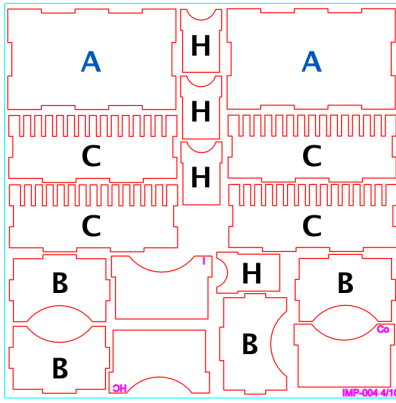

## 3D Models

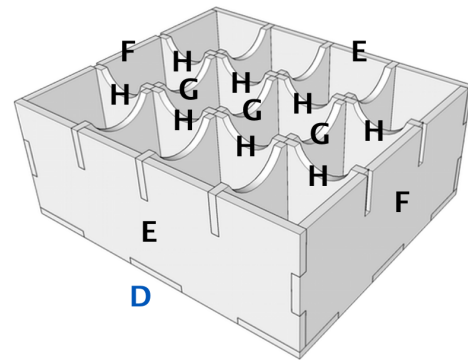
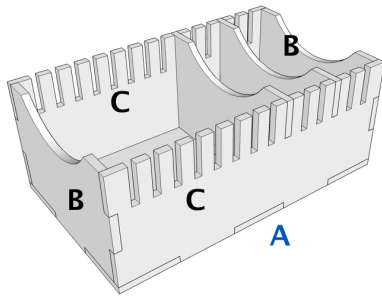

## Build Instructions

Remember, after each piece is placed, you should cleanup excess glue using the provided glue sticks (short, thin wood strips). Also, remember to dry fit everything so you understand where to place glue and how everything fits together. **Note:** dry fitting is very important when building the minis storage trays. You can dry fit and note how the minis are stored to ensure you don't make a mistake when gluing.

Next, let's build the two small card storage trays.

- 1) Lay base (A) down on your workspace. Apply glue to the bottom of long side wall (C) and apply glue to the bottom and both side tabs of end wall (B) and then connect them together on base (A).
- 2) Next, apply glue to the bottom of long side wall (C) and connect it to the structure.
- 3) Finally, place glue on the bottom and side tabs of end wall (B) and connect. You may want to place a divider or two into the tray (no glue yet) to ensure a perfect fit, just make sure you have cleaned up all of the excess glue.
- 4) Repeat build for the second small card storage tray.

Next, let's construct the two small minis storage trays (D).

- 1) Lay base (D) down on your workspace. Apply glue to the bottom of long side wall (E) and apply glue to the bottom and both side tabs of end wall (F) and then connect all three together.
- 2) Next, apply glue to the bottom of long side wall (E) and connect it to the structure.
- 3) Finally, place glue on the bottom and side tabs of end wall (F) and connect. You may want to place a divider (G) or two into the tray (no glue yet) to ensure a perfect fit, just make sure you have cleaned up all of the excess glue. Once dry, the dividers (G) and splitters (H) can be placed, as needed.
- 4) Repeat build for the second small minis storage tray.

# Kit Plate

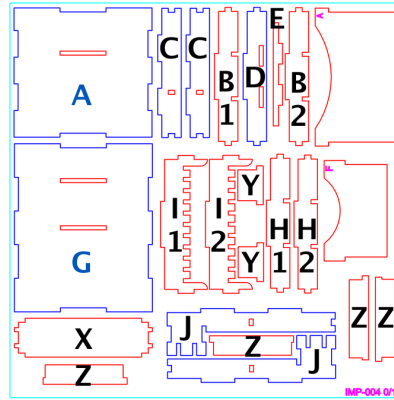

## 3D Models

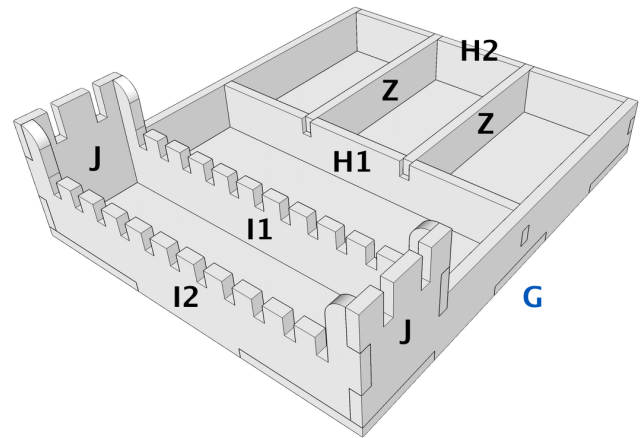
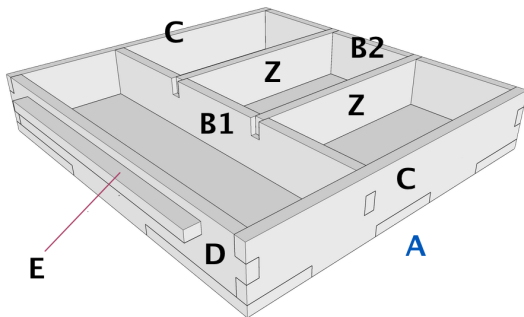

## Build Instructions

Remember, after each piece is placed, you should cleanup excess glue using the provided glue sticks (short, thin wood strips). Also, remember to dry fit everything so you understand where to place glue and how everything fits together. **Note:** dry fitting is very important when building the minis storage trays. You can dry fit and note how the minis are stored to ensure you don't make a mistake when gluing.

Next, let's construct the small token tray (A). **Note:** The two token tray builds on this page are designed specifically to store the tokens that are present in the Heart of the Empire box. If you are building this insert for use with Return to Hoth, you should not build these trays.

- 1) Lay base (A) down on your workspace. Apply glue to the bottom of wall (B1) and connect in the center of base (A).
- 2) Next, apply glue to the side tabs of wall (B1) and the bottom of long side wall (C) and connect it to the structure. Repeat for the other long side wall (C).
- 3) Next, apply glue to the side tabs and bottom of wall (B2) and connect.
- 4) Next, apply glue to the side tabs and bottom of wall (D) and connect.
- 5) Finally, place glue on the tabs of lock tab (E) and connect to wall (D).
- 6) Feel free to place the dividers (Z) once the glue has had a few minutes to set. Do not glue them until you understand how you want to store your tokens though.

Finally, let's construct the "L" token tray (G).

- 1) Lay base (G) down on your workspace. Apply glue to the bottom and side tabs of wall (H1) and connect in the center of base (G).
- 2) Next, apply glue to the bottom and side tabs of wall (I1) and connect in the center of base (G).
- 3) Next, apply glue to the bottom of long side wall (J) and connect it to the structure. Repeat for the other long side wall (J).
- 4) Next, apply glue to the side tabs and bottom of wall (H2) and connect.
- 5) Finally, apply glue to the side tabs and bottom of wall (I2) and connect.
- 6) Feel free to place the dividers (Y, Z) once the glue has had a few minutes to set. Do not glue them until you understand how you want to store your tokens though.

Allow your trays to dry overnight and then place your components into the trays. You have completed the project.